

FH160S USER MANUAL

GENERAL SPECIFICATIONS

FH160S is a floor heating room thermostat. User provides more comfortable and affordable heating by setting needed room temperature.

- Sensitive Temperature Measurement
- Wired Connection
- ON / OFF Control

FH160S AND EQUIPMENTS

FH160S Room Thermostat

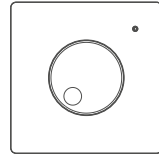

Dowels and Screws



TECHNICAL DATA

Dimensions (H / L / W)	85.7mm / 85.7mm / 33.5mm
Operating Current	230V AC
Relay NO Switching Current	7A (240VAC – Resistive load) 10A (120VAC – Resistive load)
Temperature Measurement Accuracy	0.1°C
Operating Sensitivity	0.5°C
Operating Temperature Range	(5°C) – (30°C)
Operating Temperature	(-10°C) – (+50°C)
Storage Temperature	(-20°C) – (+60°C)

ROOM THERMOSTAT

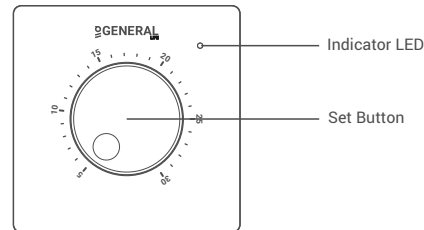

Room Thermostat Indicator LED Descriptions

LED light is on	Heating unit is working
LED light is off	Heating unit is not working

ROOM THERMOSTAT PLACEMENT

Place your Room Thermostat in a room you use frequently in your living space. For example; like the hall or living room of your home. Avoid installing the Room Thermostat in places where there is a lot of air circulation, such as at the doorway or by the window. Also, do not place it close to heating units (heater core, fireplace, etc.) and in direct sunlight. We recommend that the room thermostat is placed at a height of 150 cm from the floor.

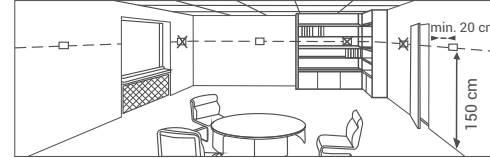

ROOM THERMOSTAT WORKING PRINCIPLE

As soon as you energize your Room Thermostat, it will start working. Your Room Thermostat measures the temperature of the environment it is in every 5 seconds. If the ambient temperature rises 0.5 degrees above the temperature you set, your Room Thermostat turns off the heating unit, and if it falls below 0.5 degrees, it turns on the heating unit.

If the floor sensor measures temperature above 28°C, it turns off the heating unit. The floor sensor operating sensitivity is ±1°C.* Thus, it is ensured that the ambient temperature remains within a certain range.

*External floor sensor is only active when it is connected.

Note: If a floor sensor is installed with Room Thermostat, only GENERAL Life floor sensor should be installed. Otherwise, the product will be out of warranty.

ROOM THERMOSTAT WIRING DIAGRAM

⑥ WARNING!
The assembly of product should be done according to the image above.
For electrical connection, please see diagram 5.
.....Should not be used in case the usage of a wiring center.

WIRING DIAGRAM FOR ACTUATOR

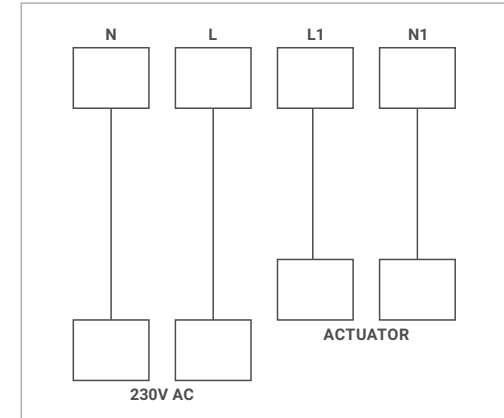

WIRING DIAGRAM FOR WIRING CENTER

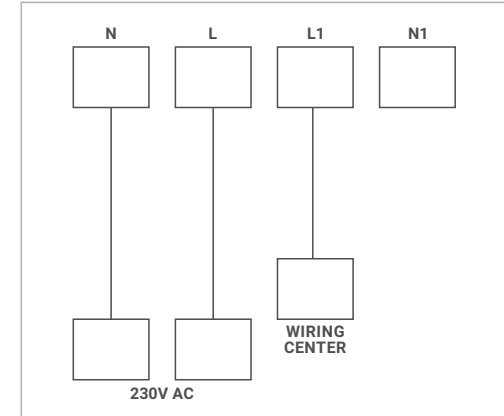

WARNING!
Operations related to the control panel, heating unit or electrical installation must be carried out by persons with professional qualifications.



DECLARATION OF CONFORMITY

ISIPARK İÇ VE DIŞ TIC. İNŞ. İSİTMA SİSTEMLERİ OTO.SAN.A.Ş. which Head Office and production site is located on Fatih Mah. 1188 Sk.No:13/A Sarnıç - Gaziemir - İZMİR - TÜRKİYE confirms and declares that the product marked with CE and its specifications below is covered by the provisions of the mentioned directive.

Brand : GENERAL Life

Product Name : FH160S

Product Type : Floor Heating Room Thermostat

Compatible Directives:

Electromagnetic Compatibility Regulation 2014/30/EU

(EN 61000-6-1:2019, EN 61000-6-3:2021)

Low Voltage Directive 2014/35/EU (EN 60730-2-9)

Additional Information: The mentioned product can be used with boilers with on / off output and compliance with the directives only covers the product. ISIPARK is not responsible for the entire system's compliance with the directives. This statement is not valid if changes are made to the product without our approval.



WARRANTY CONDITIONS

1-The warranty period starts from the invoice date and warranted against manufacturing defects for 2 years.

2-Devices and apparatus are delivered to the customer in working condition in our company. On-site commissioning is subject to a service fee.

3-The repair of the devices and apparatus covered by the warranty is carried out in our company factory and should send by contracted transportation company. In on-site services, the transportation and accommodation expenses of the service personnel belong to the customer. The shift fee during transportation is added to the service fee and collected in advance.

4-The maintenance of devices and apparatus is done in our company. For the maintenance of the devices and apparatus, the round travel fares belongs to the customer.

5-In case of malfunctioning of the devices and apparatus whose warranty period continues, it is tested in our company whether the malfunction is caused by a customer or manufacturer fault, and it is reported with a report issued by our company.

6-In case of detection of manufacturer-induced errors of devices and apparatus whose warranty period continues, the customer can request a replacement or repair of the devices and apparatus at full expense by the manufacturer, unless it's higher than the product's price.

7-In the event that the faults of the devices and apparatus whose warranty period continues are determined as caused by the customer, all expenses would be belong to the customer.

8-Customers should be aware of damages (if there is any) of product and warn manufacturer since the day warranty duration starts.If customer do not warn manufacturer with knowledge of damage, customer lose the rights of article 6.

9-Malfunctions resulting from the use of devices and apparatus contrary to the matters stated in the User Manual are not covered by the warranty.

10-Devices and their apparatus are out of warranty if they are beaten, broken or scratched by the customer.

11-Damages resulting from the use of devices and apparatus belonging to other brands and models without the approval of the manufacturer are not covered by the warranty.

12-Battery leakage and errors due to rust, oxidation and liquid contact by working in acidic / humid environments are not covered by the warranty.

13-When the product is not used for a long period (more than 15 days), remove the batteries. Otherwise, malfunctions that will occur are out of warranty.

14-Damages that may occur during the transportation of devices and apparatus are not covered by the warranty. Customers can take a transportation insurance.

15-Damages caused by mains voltage / faulty electrical installation are not covered by the warranty.

16-Devices and apparatuses are out of warranty for malfunctions caused by force majeure such as fire, flood, earthquake etc.

17-All of the devices and apparatuses, including all their parts, are under the warranty of our company.

18-In case of malfunction of the devices and apparatuses within the warranty period, the time spent during repairment period is added to the warranty period. The repair period of the product cannot exceed 20 working days. This period starts from the date of notification to the service station of the malfunction related to the product or, in the absence of a service station, to the seller, dealer, agency, representative, importer or manufacturer of the product. Consumer can report the problem by; phone, fax, e-mail, registered and reply paid letter or a similar way. However, in case of a conflict, responsibility of prove is belong to the customer. If the malfunction of the product is not repaired within 20 working days, the manufacturer-producer or importer; has to allocate another product with similar features to the use of the consumer until the repair of the product is completed.

19-Although the consumer uses his/her repair rights,

-If the product breaks down for 4 times in a year or 6 times in warranty duration and these problems effects main purpose of the product. (starting from delivery time during warranty.)

-Exceeding the maximum time required for repair,

-In the event that the service station is not available, if it is determined that the repair of the defect is not possible with the report prepared (in order) by one of the seller, dealer, agency, representative, importer or manufacturer, a refund or a price discount at the rate of defect can be requested.

20-The customer can make complaints and appeals to consumer courts or consumer arbitration committees.

21-The warranty document must be kept by the customer during the warranty period. If the document is lost, a second document will not be issued. In case of loss, repair and replacement of devices and apparatus will be made for a fee.

WARRANTY CERTIFICATE

Manufacturer

Title: ISIPARK İÇ DIŞ TIC. A.Ş.

Address: Fatih Mah. 1188 Sk. No:13/A Sarnıç

Gaziemir İzmir-TÜRKİYE

Tel: +90 (232) 457 99 50

Fax: +90 (232) 457 91 22

E-mail: generallife@generallife.com.tr

Authorized Signature:

Company Stamp:

Product

Type: Floor Heating Room Thermostat

Brand: GENERAL Life

Model: FH160S

Warranty Period: 2 Years

Max. Time to Repair: 20 Days

Bandrol and Serial Number:



Vendor

Title:

Address:

Tel:

Fax:

E-Mail:

Invoice Date and Number:

Delivery Time and Place:

Authorized Signature:

Company Stamp:

Product

Type: Floor Heating Room Thermostat

Brand: GENERAL Life

Model: FH160S

STAMP